

## Infrared Emitting Diode, RoHS Compliant, 875 nm, GaAlAs

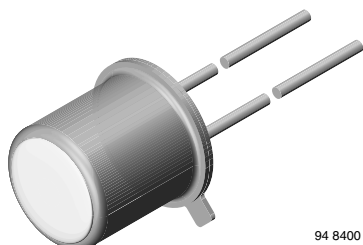

### DESCRIPTION

TSTA7500 is an infrared, 875 nm emitting diode in GaAlAs technology in a hermetically sealed TO-18 package with flat glass window.

### FEATURES

- Package type: leaded
- Package form: TO-18
- Dimensions (in mm):  $\varnothing$  4.7
- Peak wavelength:  $\lambda_p = 875$  nm
- High reliability
- High radiant power
- High radiant intensity
- Angle of half intensity:  $\varphi = \pm 30^\circ$
- Low forward voltage
- Suitable for high pulse current operation
- Good spectral matching with Si photodetectors
- Lead (Pb)-free component in accordance with RoHS 2002/95/EC and WEEE 2002/96/EC



**RoHS**  
COMPLIANT

### APPLICATIONS

- Radiation source near infrared range

### PRODUCT SUMMARY

COMPONENT	$I_e$ (mW/sr)	$\varphi$ (deg)	$\lambda_p$ (nm)	$t_r$ (ns)
TSTA7500	6	$\pm 30$	875	600

#### Note

Test conditions see table "Basic Characteristics"

### ORDERING INFORMATION

ORDERING CODE	PACKAGING	REMARKS	PACKAGE FORM
TSTA7500	Bulk	MOQ: 1000 pcs, 1000 pcs/bulk	TO-18

#### Note

MOQ: minimum order quantity

### ABSOLUTE MAXIMUM RATINGS

PARAMETER	TEST CONDITION	SYMBOL	VALUE	UNIT
Reverse voltage		$V_R$	5	V
Forward current		$I_F$	100	mA
Peak forward current	$t_p/T = 0.5, t_p \leq 100 \mu s$	$I_{FM}$	200	mA
Surge forward current	$t_p \leq 100 \mu s$	$I_{FSM}$	2.5	A
Power dissipation		$P_V$	180	mW
	$T_{case} \leq 25^\circ C$	$P_V$	500	mW
Junction temperature		$T_j$	100	$^\circ C$
Storage temperature range		$T_{stg}$	- 55 to + 100	$^\circ C$
Thermal resistance junction/ambient	leads not soldered	$R_{thJA}$	450	K/W
Thermal resistance junction/case	leads not soldered	$R_{thJC}$	150	K/W

#### Note

$T_{amb} = 25^\circ C$ , unless otherwise specified



Infrared Emitting Diode, RoHS Compliant, Vishay Semiconductors  
875 nm, GaAlAs

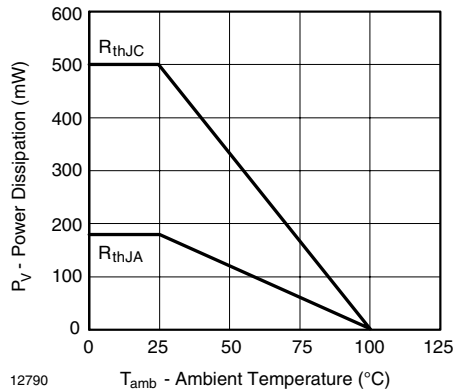

Fig. 1 - Power Dissipation Limit vs. Ambient Temperature

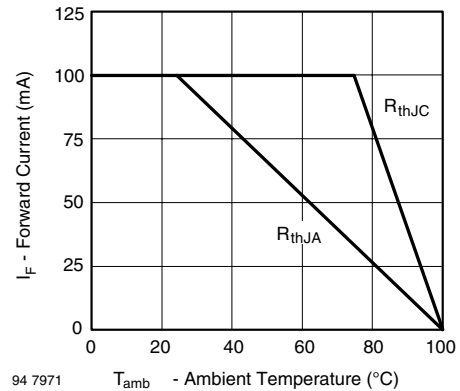

Fig. 2 - Forward Current Limit vs. Ambient Temperature

BASIC CHARACTERISTICS						
PARAMETER	TEST CONDITION	SYMBOL	MIN.	TYP.	MAX.	UNIT
Forward voltage	$I_F = 100 \text{ mA}$ , $t_p \leq 20 \text{ ms}$	$V_F$		1.4	1.8	V
Breakdown voltage	$I_R = 100 \text{ } \mu\text{A}$	$V_{(BR)}$	5			V
Junction capacitance	$V_R = 0 \text{ V}$ , $f = 1 \text{ MHz}$ , $E = 0$	$C_j$		20		pF
Radiant intensity	$I_F = 100 \text{ mA}$ , $t_p \leq 20 \text{ ms}$	$I_e$	3.5	6	16	mW/sr
Radiant power	$I_F = 100 \text{ mA}$ , $t_p \leq 20 \text{ ms}$	$\phi_e$		10		mW
Temperature coefficient of $\phi_e$	$I_F = 100 \text{ mA}$	$TK\phi_e$		- 0.7		%/K
Angle of half intensity		$\varphi$		$\pm 30$		deg
Peak wavelength	$I_F = 100 \text{ mA}$	$\lambda_p$		875		nm
Spectral bandwidth	$I_F = 100 \text{ mA}$	$\Delta\lambda$		80		nm
Rise time	$I_F = 100 \text{ mA}$	$t_r$		600		ns
	$I_F = 1.5 \text{ A}$ , $t_p/T = 0.01$ , $t_p \leq 10 \text{ } \mu\text{s}$	$t_r$		300		ns
Virtual source diameter		$d$		0.5		mm

Note

$T_{amb} = 25 \text{ }^\circ\text{C}$ , unless otherwise specified

BASIC CHARACTERISTICS

$T_{amb} = 25 \text{ }^\circ\text{C}$ , unless otherwise specified

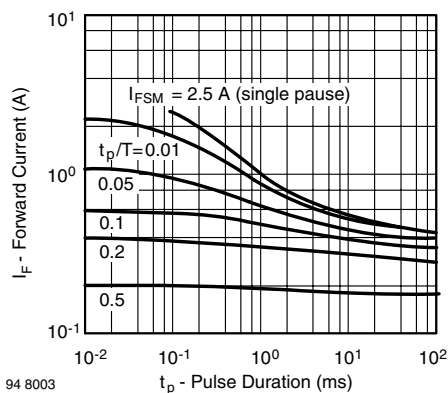

Fig. 3 - Pulse Forward Current vs. Pulse Duration

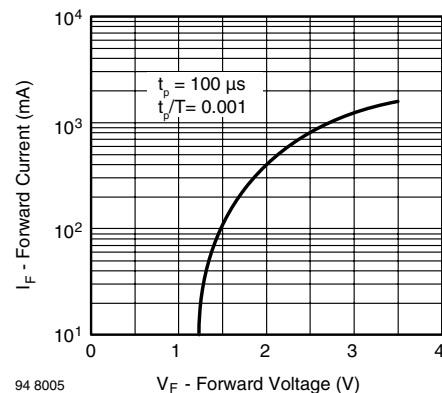

Fig. 4 - Forward Current vs. Forward Voltage



Fig. 5 - Relative Forward Voltage vs. Ambient Temperature

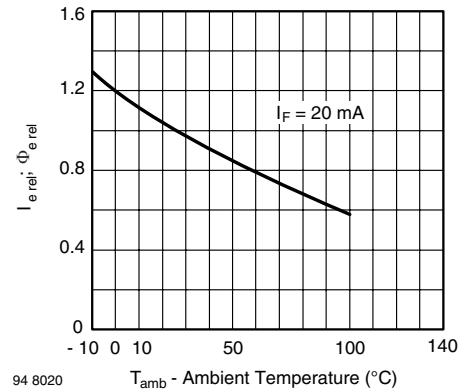

Fig. 8 - Rel. Radiant Intensity/Power vs. Ambient Temperature

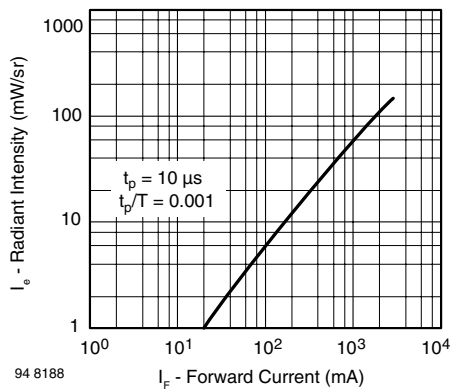

Fig. 6 - Radiant Intensity vs. Forward Current

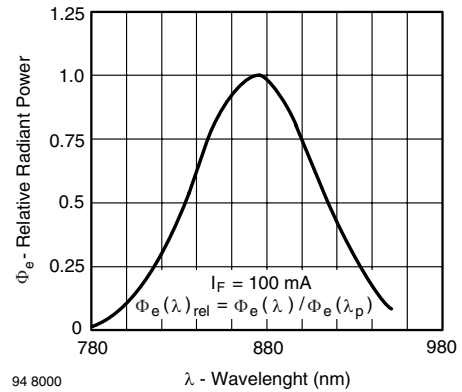

Fig. 9 - Relative Radiant Power vs. Wavelength

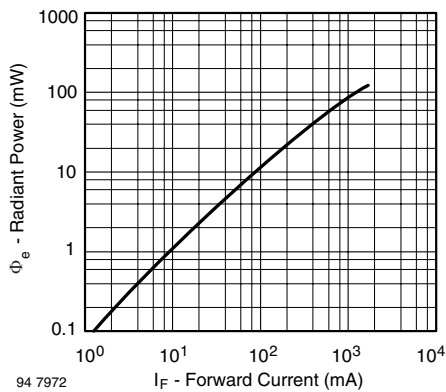

Fig. 7 - Radiant Power vs. Forward Current

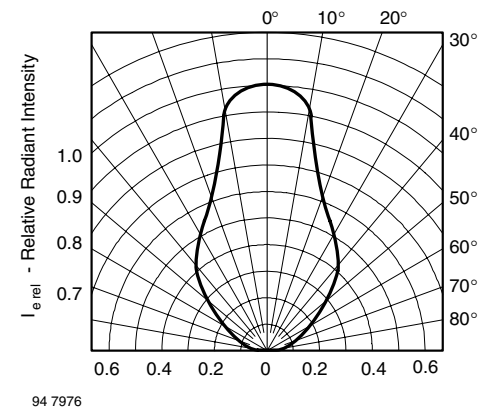
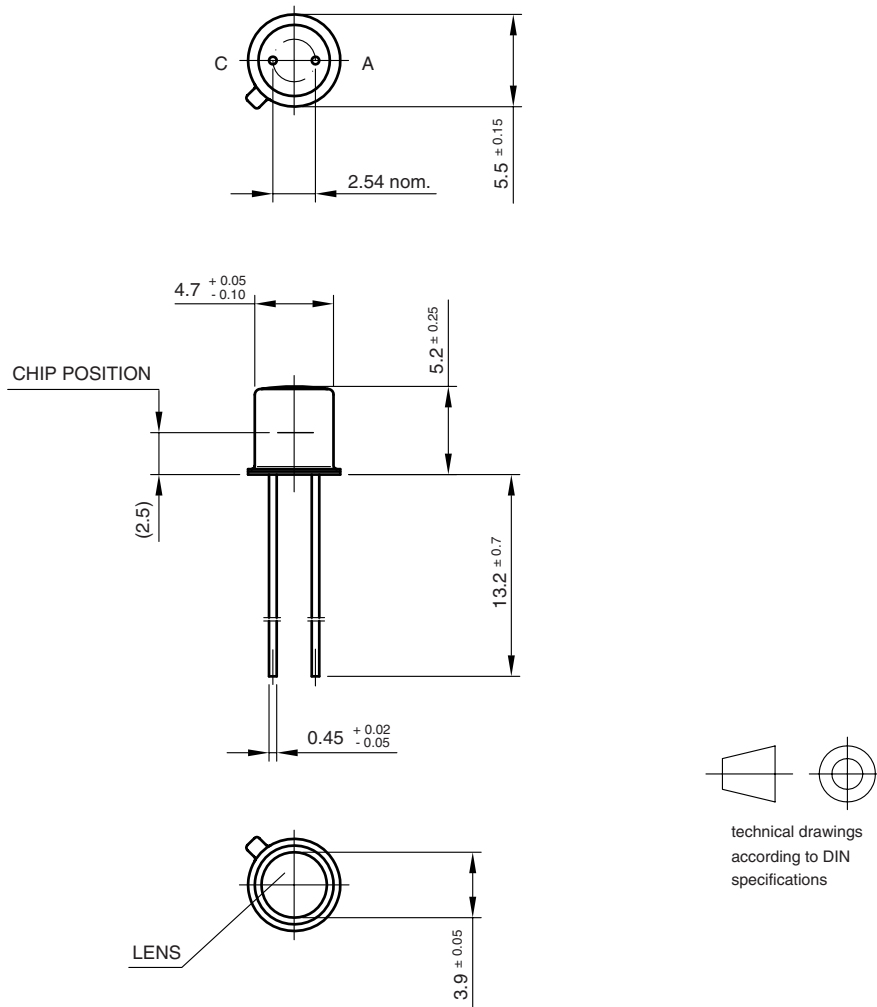

Fig. 10 - Relative Radiant Intensity vs. Angular Displacement



**PACKAGE DIMENSIONS** in millimeters



Drawing-No.: 6.503-5001.01-4  
Issue: 2; 24.08.98  
96 12173



## Disclaimer

All product specifications and data are subject to change without notice.

Vishay Intertechnology, Inc., its affiliates, agents, and employees, and all persons acting on its or their behalf (collectively, "Vishay"), disclaim any and all liability for any errors, inaccuracies or incompleteness contained herein or in any other disclosure relating to any product.

Vishay disclaims any and all liability arising out of the use or application of any product described herein or of any information provided herein to the maximum extent permitted by law. The product specifications do not expand or otherwise modify Vishay's terms and conditions of purchase, including but not limited to the warranty expressed therein, which apply to these products.

No license, express or implied, by estoppel or otherwise, to any intellectual property rights is granted by this document or by any conduct of Vishay.

The products shown herein are not designed for use in medical, life-saving, or life-sustaining applications unless otherwise expressly indicated. Customers using or selling Vishay products not expressly indicated for use in such applications do so entirely at their own risk and agree to fully indemnify Vishay for any damages arising or resulting from such use or sale. Please contact authorized Vishay personnel to obtain written terms and conditions regarding products designed for such applications.

Product names and markings noted herein may be trademarks of their respective owners.